

YARBO

MEET YARBO

A Multi-purpose Intelligent Robot to Meet All-season
Yard Maintenance Needs.





YARBO

YARD WORK INNOVATION

TABLE OF CONTENTS

01	02
MARKET ANALYSIS	

02	03
PRODUCT INTRODUCTION	

03	16
VISION OF THE FUTURE	

04	18
COMPANY PROFILE	

05	19
WHY CHOOSE YARBO?	

01

MARKET ANALYSIS



Heavy snowfall is common in winter in many areas; the grass never stops growing in warm climates and needs constant mowing; leaves are always on the ground in the Fall. Yards need to be maintained 24/7 all year long.

People are often exposed to harsh weather when doing yard work outside, such as rain, sleet, snow, and extreme heat and cold temperatures.

Traditional yard care tools/equipment require hard work, which is time-consuming, back-breaking, and dangerous. It's also costly for homeowners to hire companies to do this work, and it's only getting more expensive as labor rates continue to increase.



PRODUCT INTRODUCTION

02

Yarbo is an all-in-1 intelligent yard robot. The combinations of a universal body and various compatible modules provide a complete set of yard maintenance solutions for every season.

- All-season Yard Care
- Interchangeable Modules
- Smart Path Planning
- Obstacle Avoidance System
- Lithium-ion Battery
- Perimeter-wire Free
- Real-time Monitoring
- Anti-theft Function
- WIFI/4G Connection
- Smart APP control

YARBO'S 3-IN-1 INTELLIGENT YARD ROBOT

Yarbo launched its brand-new product in 2022, a 3-in-1 intelligent yard robot that is hyperfocused on 3 common yard care use cases: snow removal in winter, lawn mowing in spring, summer, and autumn, and leaf/debris blowing all year long.



STRUCTURE DIAGRAM

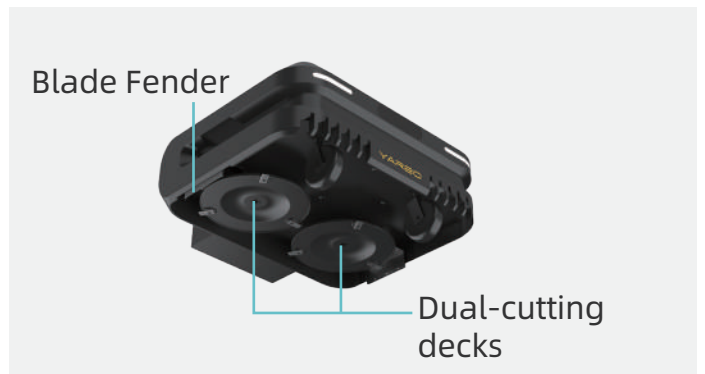
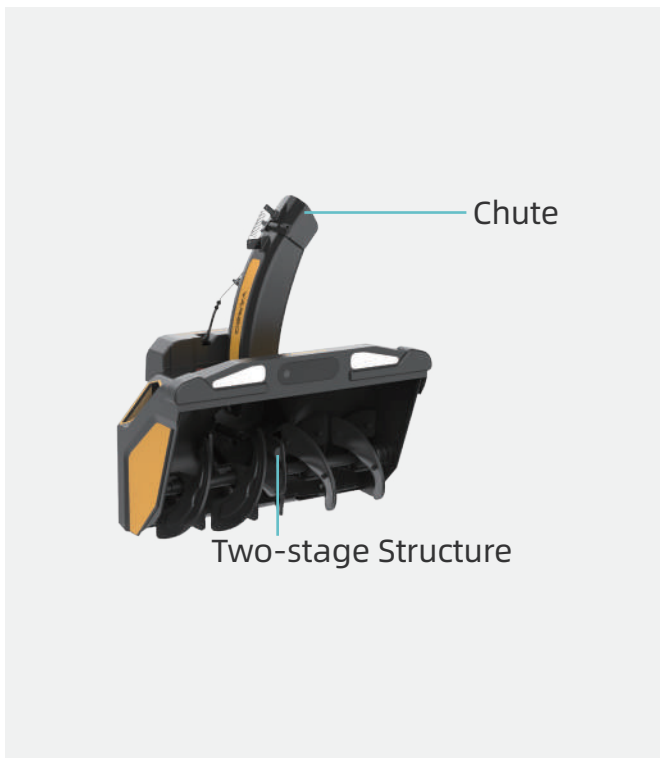





YARBO SNOW BLOWER S1

Yarbo Snow Blower S1 is a two-stage blower used for efficiently removing snow from driveways or sidewalks. The brushless motor always provides strong power for the rubber tracks, ensuring great traction, something that's critical while working out in snow storms.

 Cleaning Width:
21 inches

 Intake Height:
12 inches

 Throwing Distance:
6-40 ft

 Chute Rotation:
0-180°

 Adjustable Chute
Angle: 0-45°

 Type of Snow:
Dry/Wet/Packed Snow

 Applicable Surface:
Asphalt/Block/Brick/Cement



YARBO LAWN MOWER M1

Yarbo Lawn Mower M1 is an autonomous lawn mowing robot that will free you from cutting the lawn. Without repetitive and boring lawn mowing work, you will have more free time for meaningful things. The RTK-GPS positioning technology and advanced algorithms enable the mower to work within virtual boundaries, which means no need to bury wires/cables anymore.



Cutting Height:
1.2-4 inches



Cutting Width:
20 inches



Applicable
Slope: 68%



Max. Slope at
Boundary: 36%



Waterproof Level:
IPX6



YARBO BLOWER B1

Yarbo Blower B1 is used to blow leaves/debris into designated areas. Some use cases include your front/back yard, driveway, patio, etc. The air speed/volume/blowing directions can be easily adjusted to meet different needs.



Blowing Speed:
119 MPH



Air Volume:
424 CFM



Max. Slope at
Boundary: 36%

PRODUCT FEATURES



Auger+Impeller

Yarbo S1 has a two-stage setup. The auger gathers the snow quickly, and then the impeller shoots the snow out of the chute up to 40 ft away.



Chute

The chute can rotate for 180°, and the angle is adjustable from 0-45°. After specifying snow-throwing areas, Yarbo S1 will adjust the snow-throwing distance and directions autonomously to throw snow into the designated areas.

Dual Cutting Discs

Each cutting disc of Yarbo M1 is equipped with 3 blades. With the blades rotating at high speed, Yarbo M1 can achieve perfect mowing without missing a single blade of grass. The cutting width is 20 inches, and it provides an adjustable cutting height of 1.2-4 inches, one of the largest ranges of any robot lawn mower.

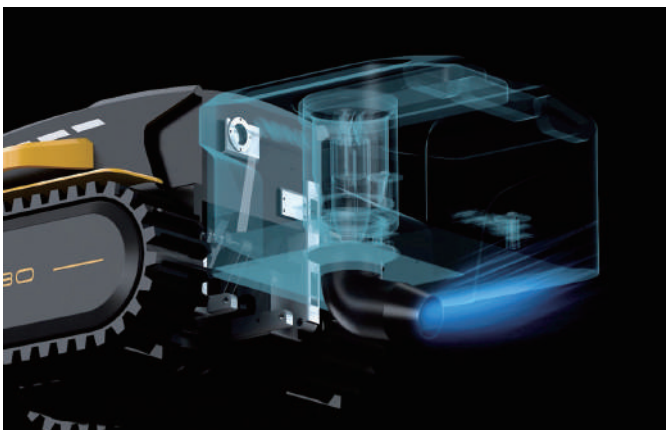
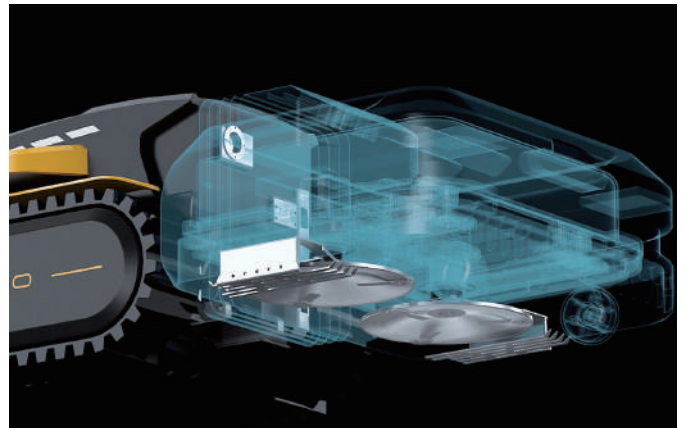

Blow Tube

The blow tube under the head of Yarbo B1 is flexible and adjustable. It can rotate to blow leaves and debris into one or more designated areas.



Lithium-ion Battery

The robot is powered by a 36-Volt 38.4 Ah lithium-ion battery that is low temperature resistant and can be charged in an outdoor environment of -22°F (-30°C). It has a thick steel shell to ensure safety and reliability, and a cycle life of up to 1000 times for long-term work.

POWERFUL DRIVE SYSTEM

Yarbo is equipped with anti-slip rubber tracks to ensure superior traction. The design of the vertically articulating attachment (linear actuator) makes Yarbo able to traverse uneven or rough terrain with small obstacles like stones and bumps. The DC brushless motor always provides strong power and traction for the tracks to easily go through wet and hard snow with a small amount of ice. Yarbo can climb up to a maximum slope of 68%. It's almost all-terrain capable!



Rubber Tracks



Motor



Vertically Articulating Attachment

■ SECURITY SYSTEM TO KEEP KIDS & PETS SAFE



Specifications	Yarbo Snow Blower S1	Yarbo Lawn Mower M1	Yarbo Blower B1
Length	39"	46"	41"
Width	24"	24"	20"
Height	16" (without the chute); 26" (with the chute)	16"	16"
Weight (Including the battery)	143 lbs	121 lbs	110 lbs
Application scenarios	Snow removal	Lawn mowing	Leaf/debris blowing
Applicable Slope	36%	68%	68%
Waterproof Level	IPX6	IPX6	N/A
Working Area/Hour	5 inches 1434 ft ²	6458 ft ²	6534 ft ²
Working Area/Charge	5 inches 2152 ft ²	12917 ft ²	5663 ft ²
Operational Time/Charge	5 inches 90 mins	Approx. 120 mins	50 mins
Running Speed	0.3 m/s	0.4 m/s	0.4 m/s

*Comparison of Yarbo S1, M1, B1

TECHNOLOGY ADVANTAGES

PRECISE POSITIONING VISION SYSTEM (PPVS)

PPVS is Yarbo's proprietary fusion technology, which integrates RTK-GPS, Computer Vision, and a myriad of other sensors to help achieve a centimeter-grade accurate positioning.

- Autonomous Navigation & Accurate Positioning

With RTK technology, Yarbo can locate itself accurately and achieve autonomous navigation. It helps to set up working areas without the need to place beacons or bury wires/cables around the yard. The satellite coverage area could be up to 12 miles. Combined with magnetic field technology, there's no need to worry even if the satellite signal is temporarily obscured or lost.

- Intelligent Path Plan & Set Multiple Work Plans

Because of the adoption of advanced algorithms, Yarbo can autonomously plan its working paths and set multiple work plans. It can handle various types of yards, either with multiple areas or in irregular shapes. It will develop the optimal working paths and the best working plan. When using the M1 Lawn Mower module, Yarbo will intelligently change the angle of its mowing path for each mowing session to prevent ruts and tracks from being formed in your lawn.





- **Automatic Obstacle Detection and Avoidance**

With millimeter-wave radar and a camera built into each module, Yarbo can sense obstacles within about 5 ft ahead accurately and reroute for a detour in advance to avoid collisions.

■ WIRELESS AUTO-RECHARGING

Yarbo will return to the docking station for charge when it's at a low power, which ensures Yarbo to work 24/7/365 to avoid the accumulation of snow or fallen leaves, and to keep the lawn perfectly maintained. Yarbo will continue its work after recharging; this helps to expand its working area. Since there are no exposed contactors, there will be no electrical hazard or risk of corrosion from melting snow or rain.



Hands-free Yard Work with App

Use Yarbo App to customize your work plans and experience easy yard work with several finger taps on your mobile phone.

The App helps you monitor the robot's working indicators in real time and gives you a live view of its working state.



Set working areas

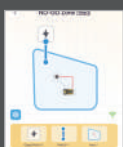

Create no-go zones & paths



Specify snow-throwing/leaf-collecting area

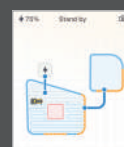

Autonomous path planning



Optional Accessory: Remote Controller

Make yard work into a game by remotely controlling Yarbo with Yarbo's remote controller! This is also a useful feature in the event that you lose power and can't run an autonomous plan.



YARBO POWER STATION

In the heart of Yarbo is a 1382 Wh capacity lithium-ion battery. It can be taken out and placed into our portable power station case to power various electronic equipment and home appliances, for example, your smartphones, MacBook, drone, camera, projector, speaker, laptop, cooler, etc. Whether there is a power outage at home or you are out camping, it will be a good partner of your life.



APPLICABLE SCENARIOS



Battery Type	Nominal Capacity	Nominal Voltage
lithium-ion battery	38.4 Ah	36 V
Weight	Charging Time	Battery Management System
Approx. 22 lbs	Approx. 2h	Over-heating, short circuit, over-current, and over-charge protection

* Specifications of Yarbo Battery

Battery Type	Charging Method	Size	Net Weight
Lithium-ion Battery	AC Wall Outlet	13.8*11.4*11.8 in	28 lbs
Capability	AC Output (*3)	USB-A Output (*2)	USB-C Output (*2)
1382 Wh	Pure Sine Wave, 600 W total (surge 1200 W), 120 V~ (50 Hz / 60 Hz)	5 V DC, 2.4 A, 12 W Max, per port	5/9/12/15/20 V, 3.25 A, 65 W Max, per port

* Specifications of Yarbo Power Station

TOW HITCH ACCESSORY

Each Yarbo is designed to be able to add a tow hitch to work with a trailer, which expands the capability of Yarbo. It can be used to tow various yard tools like a lawn sweeper, lawn roller, dump cart, dethatcher, lawn aerator attachment, etc. with strong traction provided by both the high-torque motor and rubber tracks.



03

VISION OF THE FUTURE



Yarbo is on a mission to disrupt both the yard care and outdoor power equipment market as we know it. In fact, plans are afoot to introduce additional modules including Yarbo Sprinkler for irrigation and spraying pesticides, Yarbo Plow to push snow to sides of driveways and sidewalks, Yarbo Guard that provides surveillance, tows trashcans, and collects packages, etc.



Yarbo Sweeper



Yarbo Arm



Yarbo Sprinkler



Yarbo Vacblow



Yarbo Plow



Yarbo Guard

APPLICABLE SCENARIOS



OUR ADVANTAGES



Endless Use Cases



Simple and Safe



Environmentally Friendly



Constantly Innovating



Independent R&D

04

COMPANY PROFILE

Yarbo Inc. is an innovative technology company with independent R&D technology. As an intelligent outdoor power equipment manufacturer, Yarbo Inc. focused on yard maintenance, and our main business is to provide autonomous yard robots.

Yarbo was derived from Snowbot. It was originally just an idea of making a snow blower robot in 2017. Then, after five years of development and countless product tests and iterations, the company launched the world's first autonomous snow removal robot for residential use – that is Snowbot S1, the beta test version. Now, it comes to Yarbo, which can already cover most of the yard service needs.

Yarbo will be dedicated to developing intelligent yard robots that can meet all-season and multi-use case demands. Our goal is to become the world leader in intelligent outdoor power equipment.

HISTORY OF YARBO INC.

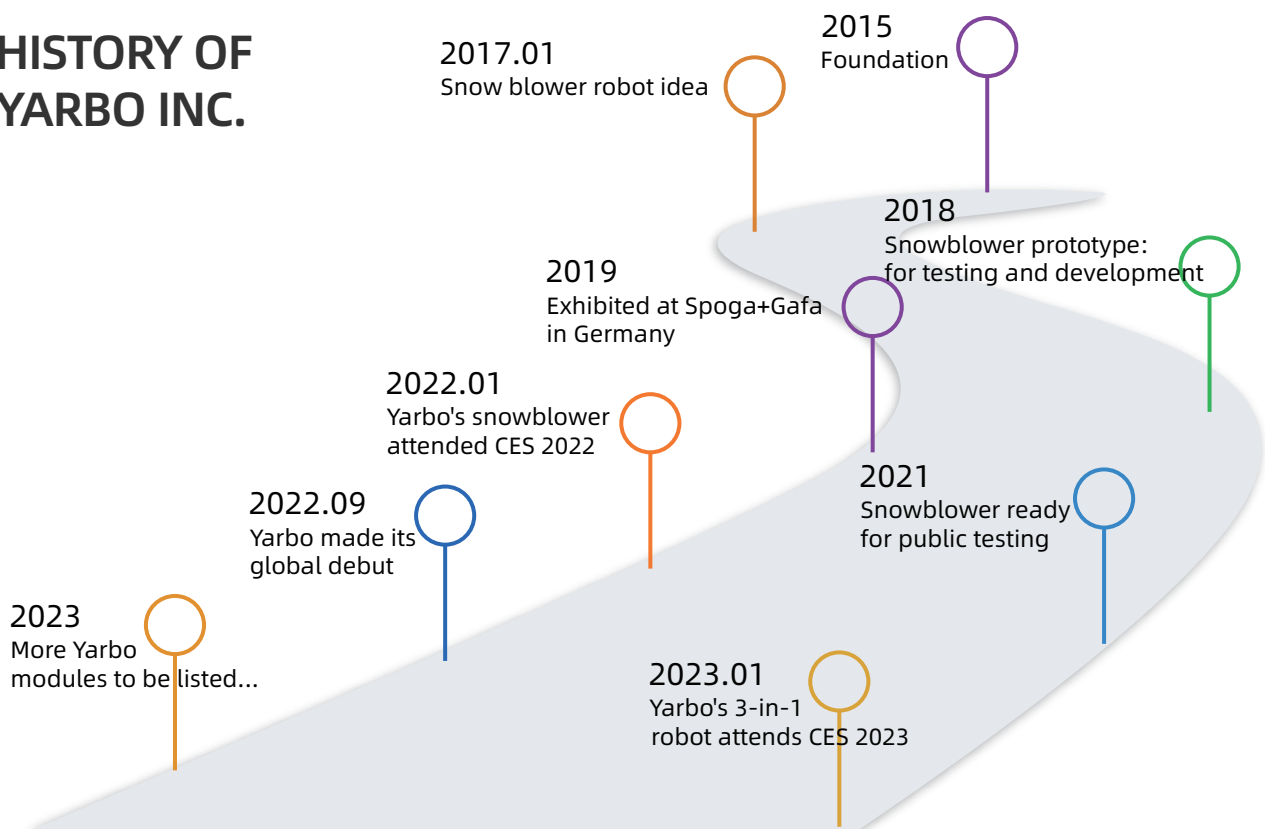

WHY CHOOSE YARBO?

05

- **An Excellent Team with Core Cohesion**

Yarbo brings together high-end talents (R&D personnel makes up more than 50% of the team) and builds a passionate team. It is a young team, with the post-90s generation accounting for the majority. Yarbo members are never afraid of difficulties – they always grasp the nettle and make positive progress.

- **Industry-leading & Innovative Designed Product**

Yarbo is an all-in-1 intelligent robot for almost all yard care needs. The universal body is capable of swapping different modules for different requirements. This allows it to be tailored to specific yard care needs without the demand of purchasing multiple robots to accomplish various tasks. This is an ingenious invention in the yard robotic industry.

- **Independent Research & Development**

Yarbo team has independent research & development technology, since most of Yarbo's senior leaders have master's degrees in science and engineering. The adoption of PPVS innovative system and linear actuator/vertically articulating attachment enable Yarbo to achieve accurate positioning and all-terrain capability, respectively.

- **"CES 2023 Innovation Awards" Honoree**

Yarbo has successfully become one of the "CES 2023 Innovation Awards" honorees with its 3-in-1 intelligent yard robot. It stands out from the rest, because its unique innovation, excellent design philosophy, and multi-purpose functionality bring great value to families.

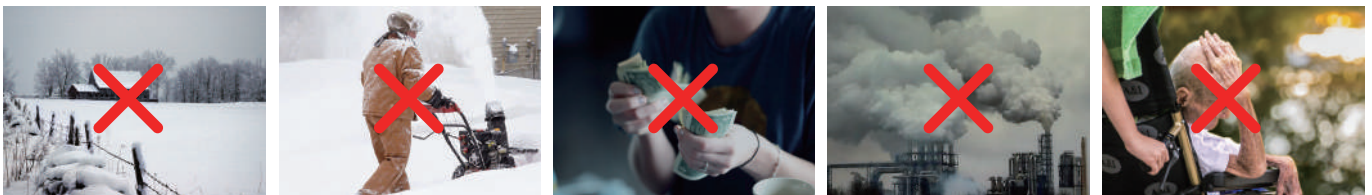

**HAVE A PERFECTLY
MAINTAINED YARD 24/7
WITH YARBO!**



CONTACT US



Tel: +1 (631) 818-1850



Business partners: dealer@yarbo.com



For other requests: contact@yarbo.com



1951 Ocean Avenue Unit 3, Ronkonkoma, NY 11779, United States.

YARBO

<https://www.yarbo.com>



 [yarbo.com](https://www.yarbo.com)



 Facebook



 Instagram



 Twitter



 YouTube



 LinkedIn